

**WATER**

**W1**

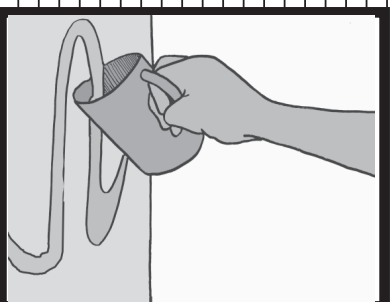

**W1 WATER - Index**

- W1 Woman walking away from tap
- W2 Polluted communal tap with dog
- W3 Children playing with bucket water
- W4 Boy putting finger up tap
- W5 Woman putting hand on tap
- W6 Man cleaning communal tap
- W7 Man testing communal water
- W8 Open bucket no lid
- W9 Bucket with lid
- W10 Bucket half covered
- W11 Bucket covered with cloth
- W12 Dirty jerry can with lid
- W13 Drum with jerry can on top
- W14 Plastic juice bottle
- W15 Poison bottle

**ACTIVITY: Three Pile Sorting      TIME: 1 Hour**

1. Divide participants into smaller groups of 10-16.
2. Give out a set of cards to each group, and ask each person to select one card each.
3. Each person should describe the card they have selected to their own group.
4. Each group should discuss all the cards and sort them into three piles according to how safe they are:
  1. Safe
  2. Unsafe
  3. Not sure
5. Once all groups have sorted their cards, let them feed back to the whole group on their decisions and why, and encourage debate.
6. At the end the group should decide on the best source of water and best method of carrying and storing drinking water.

**ACTIVITY: Good Water Song      TIME: 1 Hour**

**Make up a song using cards W2-W16 (also use cards from 'D' Drinking set)**

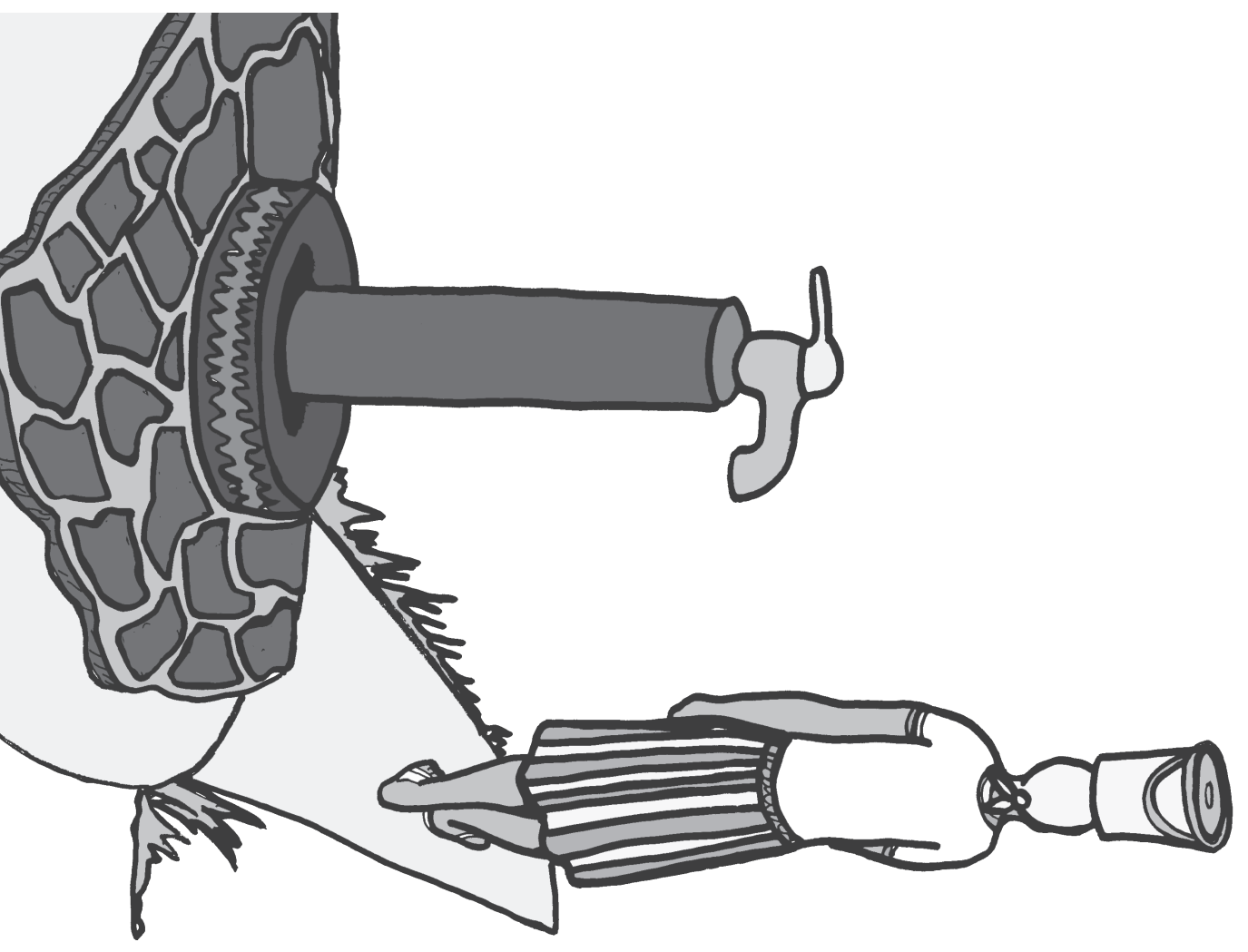
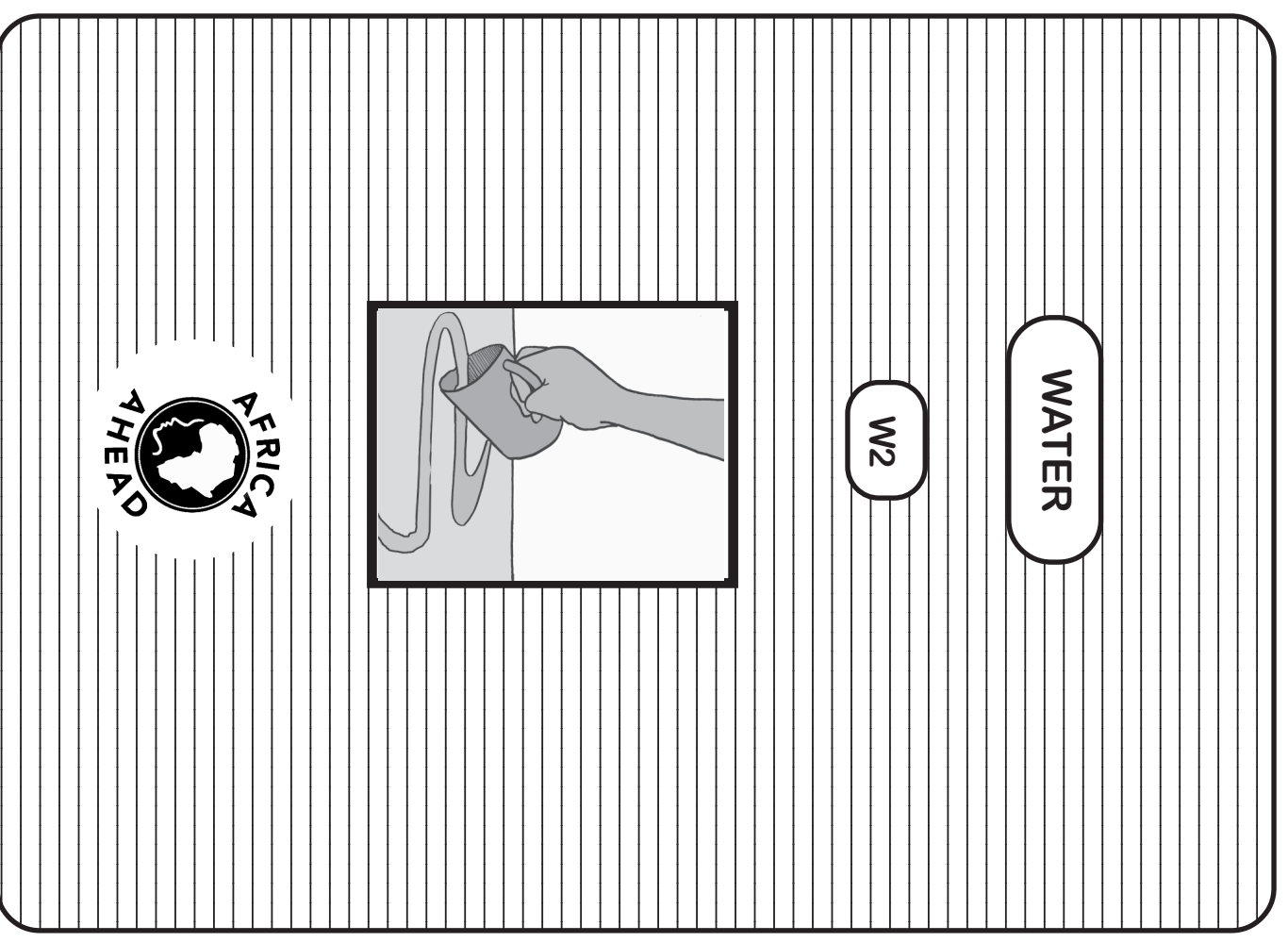



Visual Aids developed by J.Waterkeyn, (Africa AHEAD) for City Health Department Cape Town, 2007.  
Funded by Danida / Hygiene Promotion Partnership.  
Illustrator: T Waterkeyn

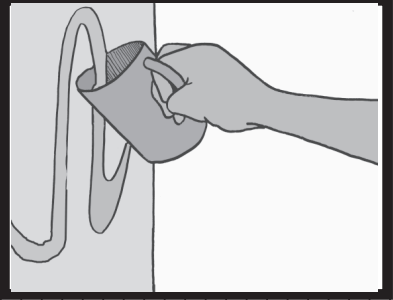

**WATER**

**W3**

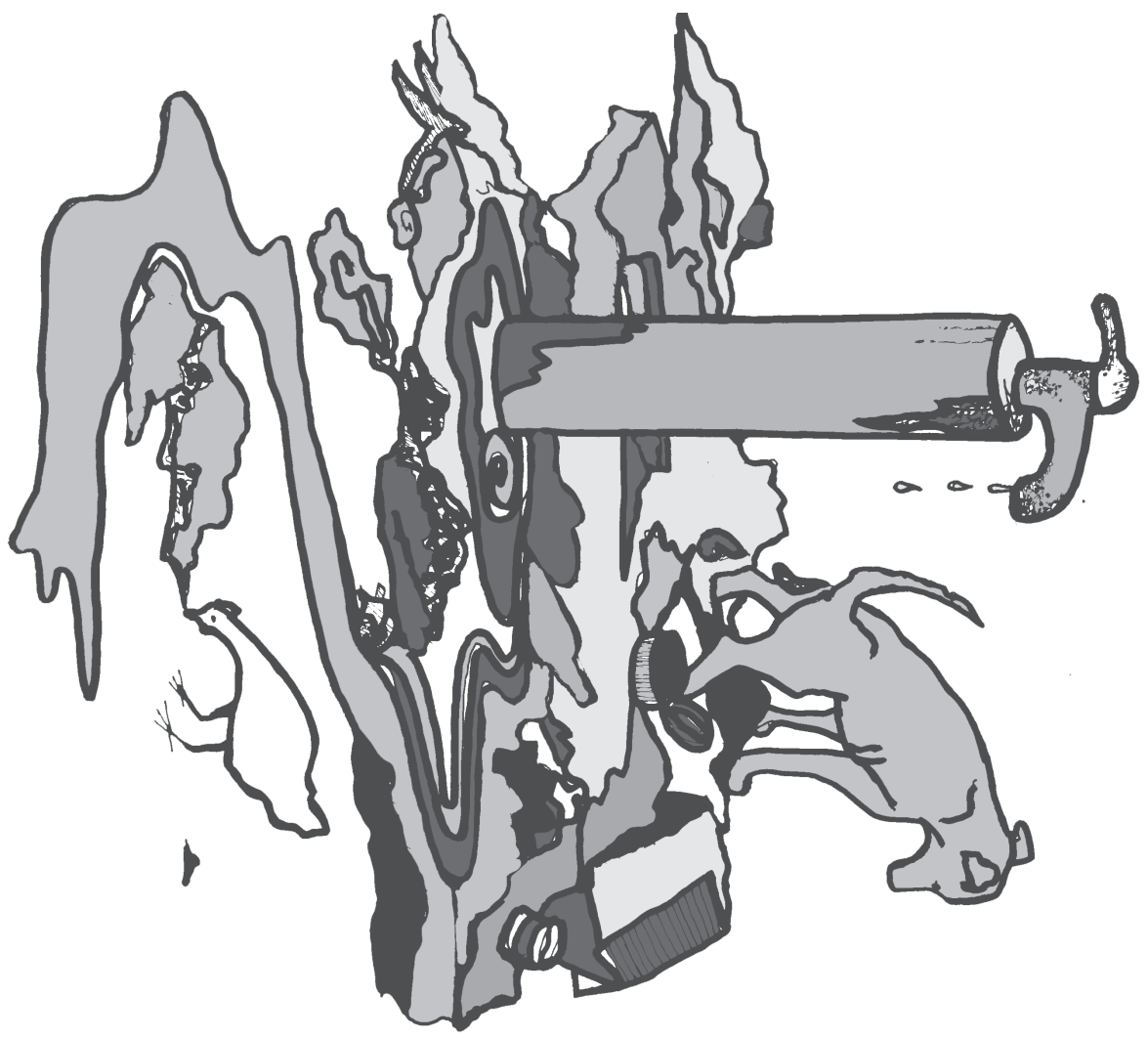





Visual Aids developed by J.Waterkeyn, (Africa AHEAD) for City Health Department Cape Town, 2007.  
 Funded by Danida / Hygiene Promotion Partnership.  
 Illustrator: T Waterkeyn

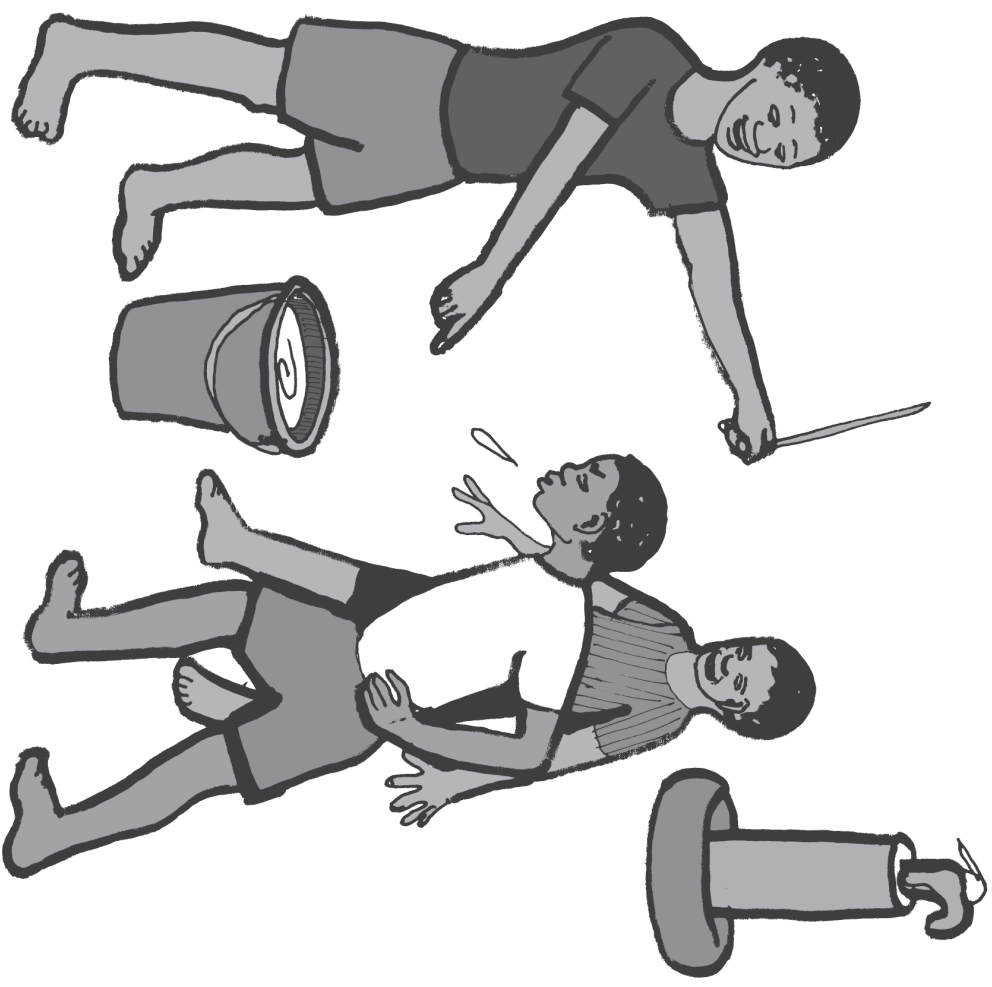

**WATER**

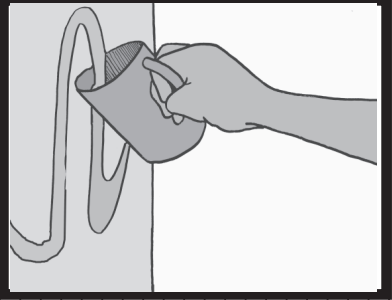
W4



Visual Aids developed by J. Waterkeyn, (Africa AHEAD) for City Health Department Cape Town, 2007.  
Funded by Danida / Hygiene Promotion Partnership.  
Illustrator: T. Waterkeyn

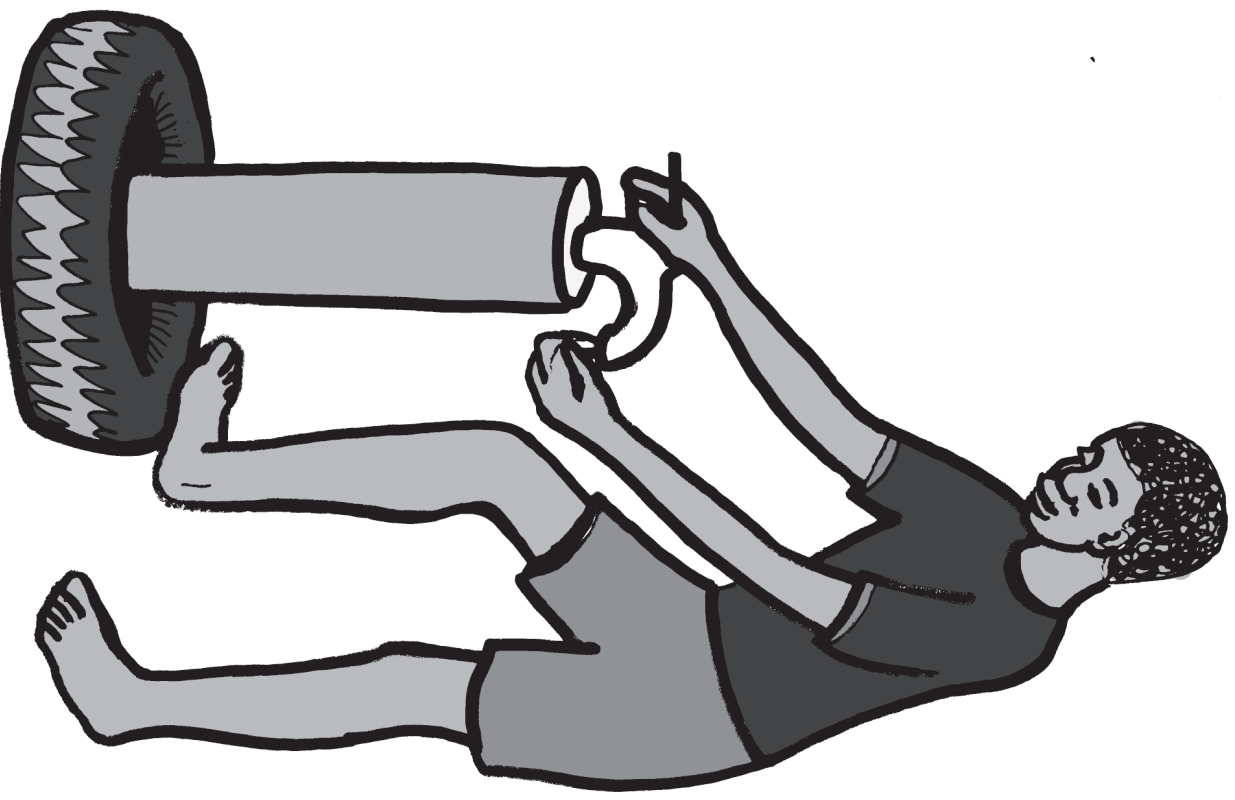
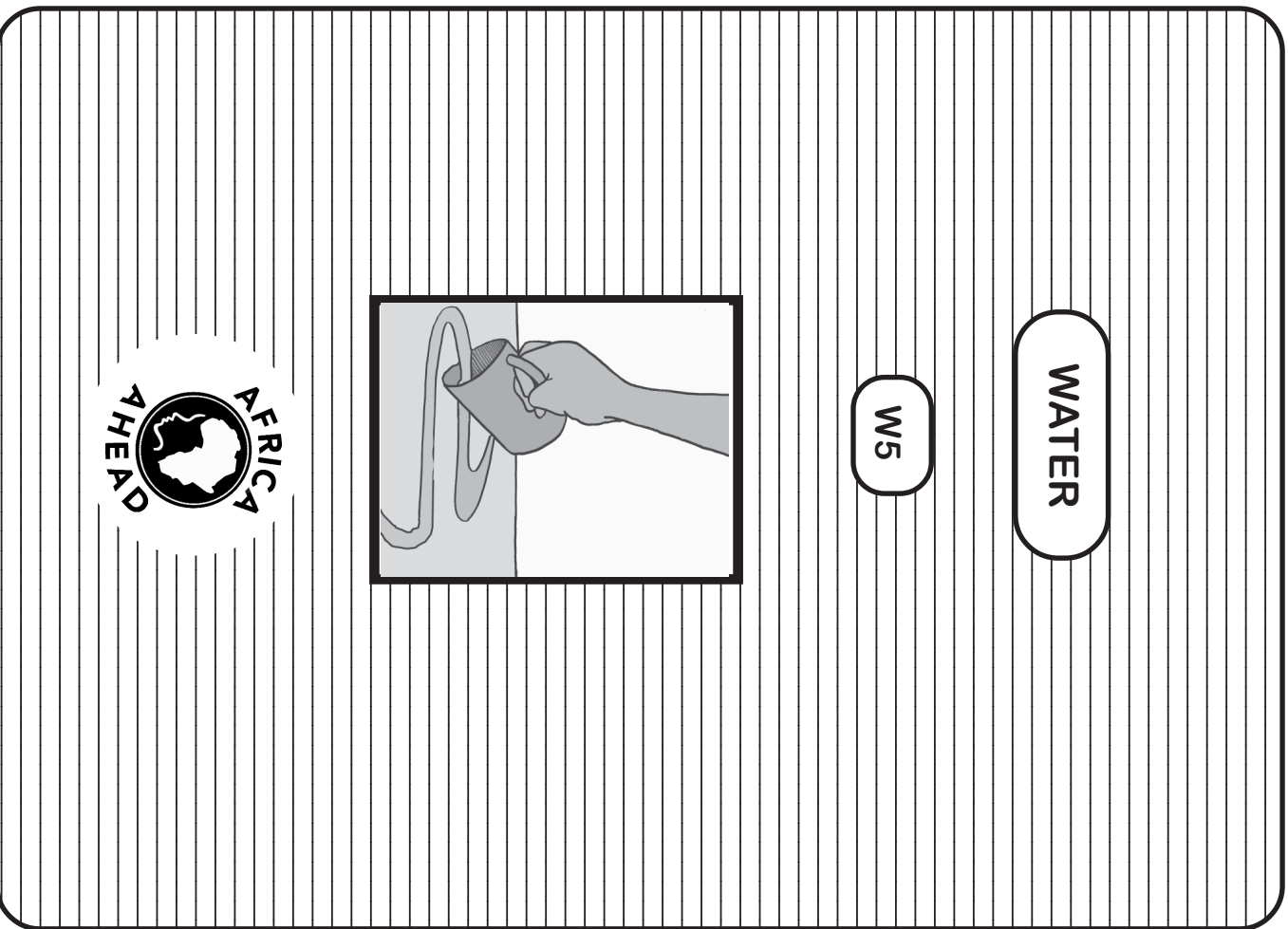

Visual Aids developed by J.Waterkeyn, (Africa AHEAD) for City Health Department Cape Town, 2007.  
Funded by Danida / Hygiene Promotion Partnership.  
Illustrator: T Waterkeyn

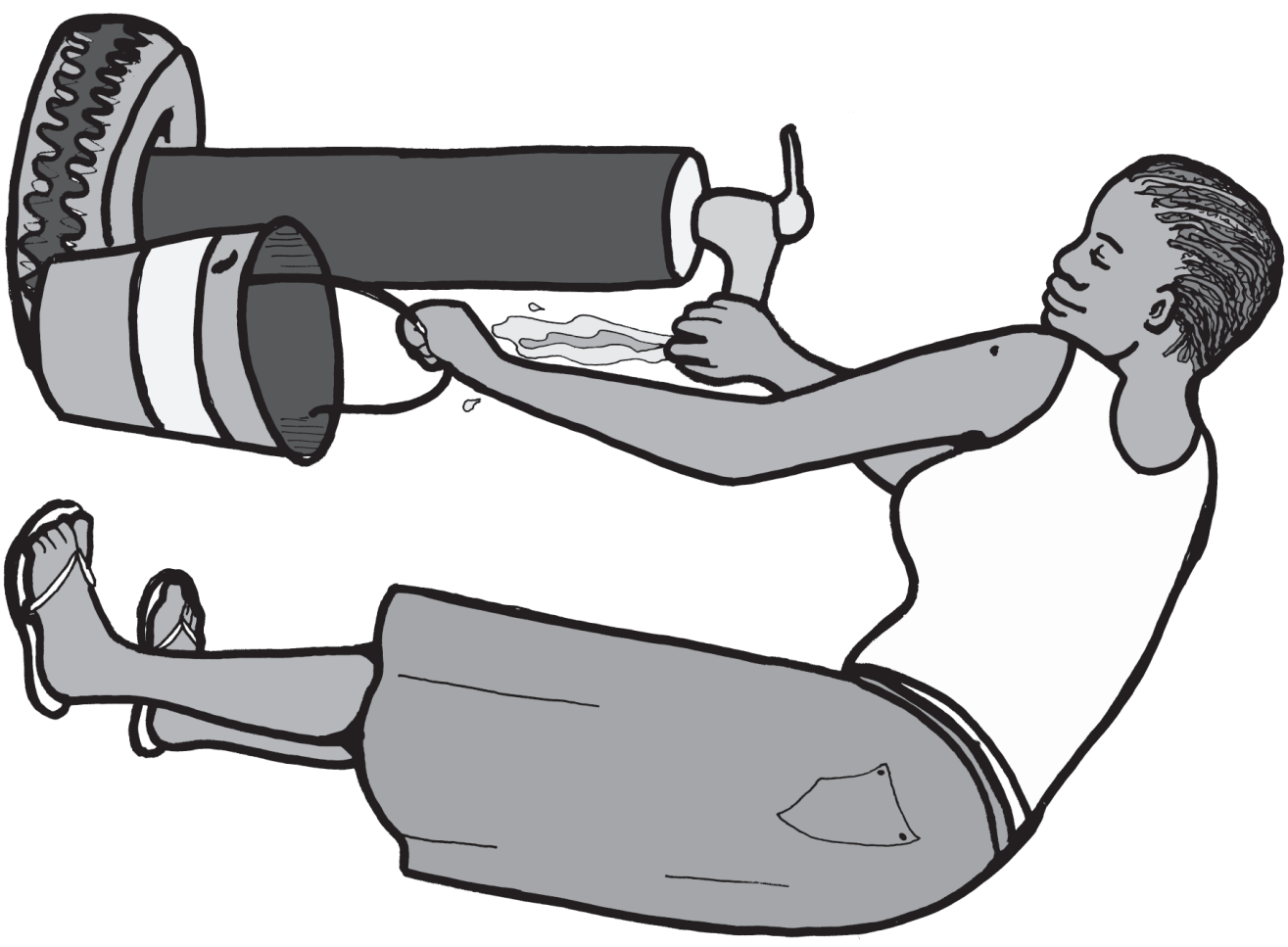
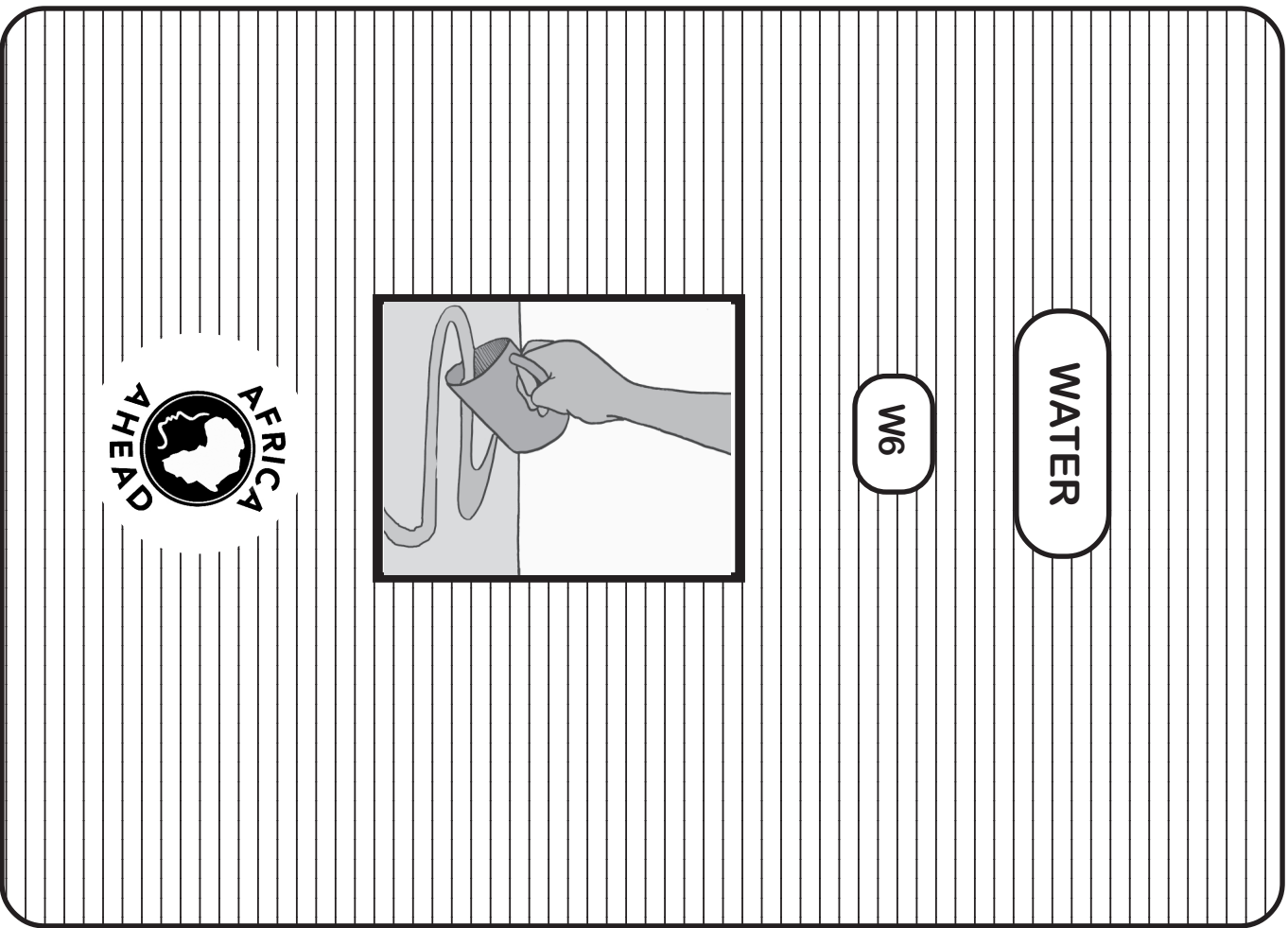

Visual Aids developed by J.Waterkeyn, (Africa AHEAD) for City Health Department Cape Town, 2007.  
Funded by Danida / Hygiene Promotion Partnership.  
Illustrator: T Waterkeyn

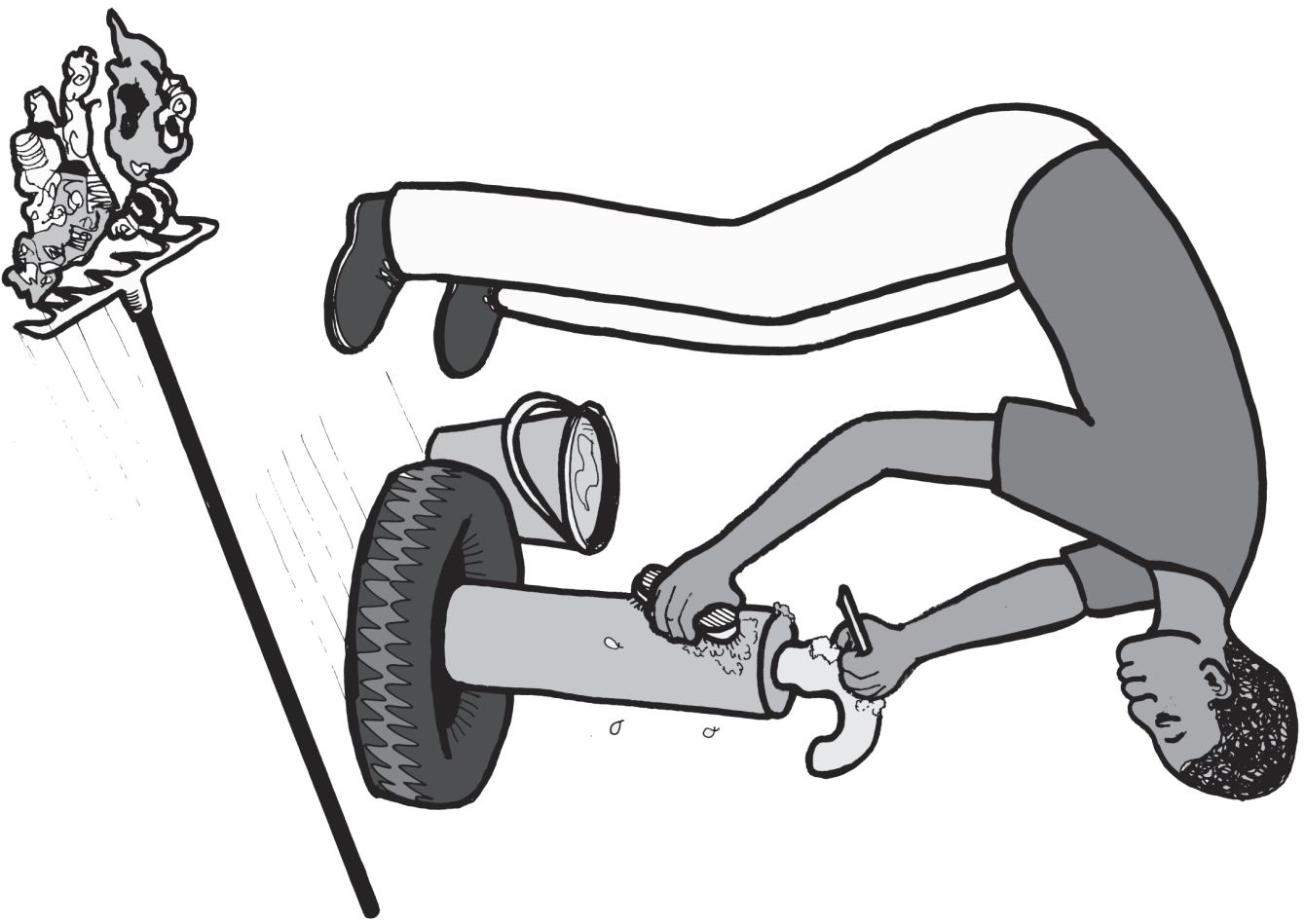
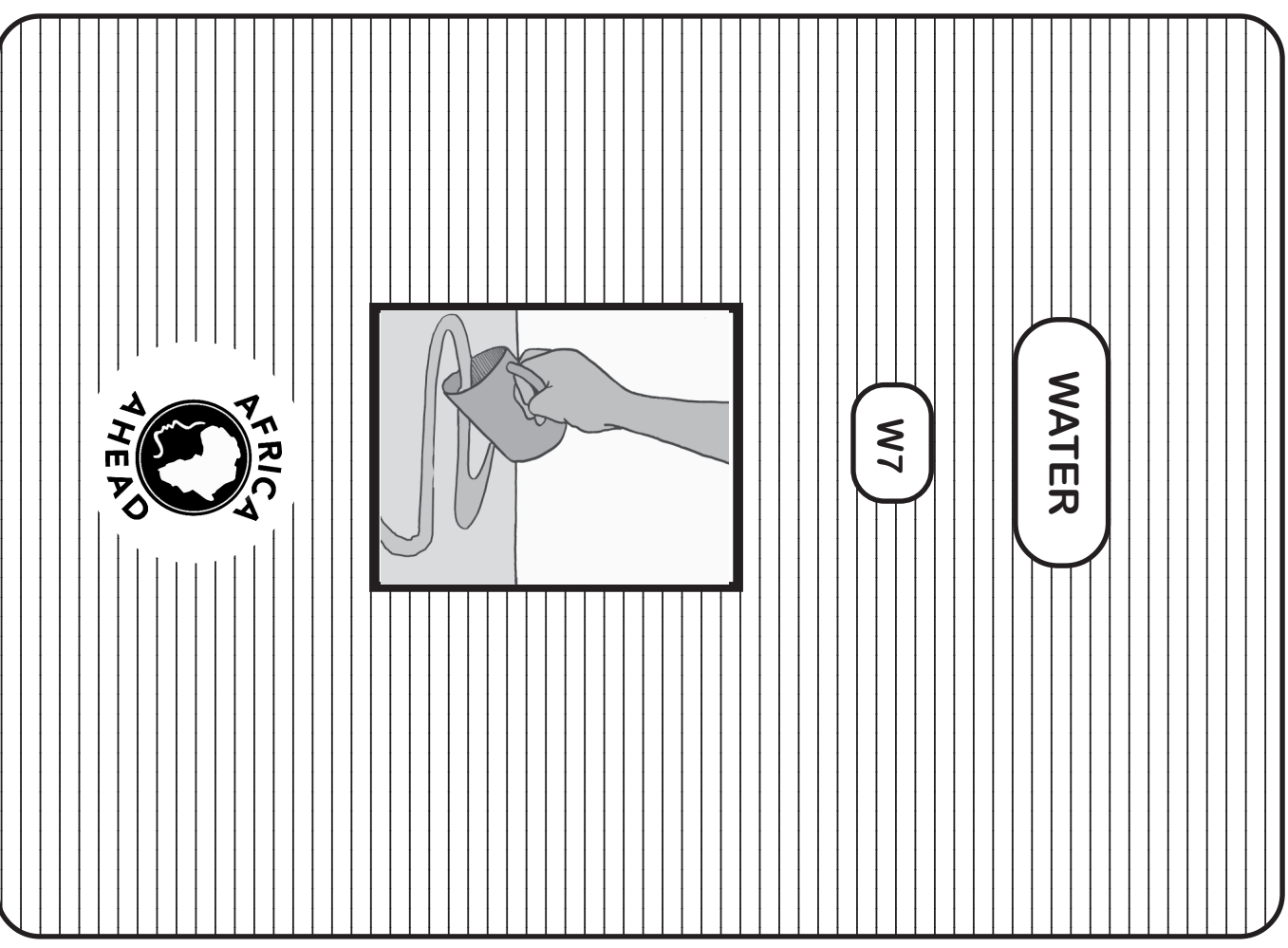

Visual Aids developed by J. Waterkeyn, (Africa AHEAD) for City Health Department Cape Town, 2007.  
 Funded by Danida / Hygiene Promotion Partnership.  
 Illustrator: T. Waterkeyn

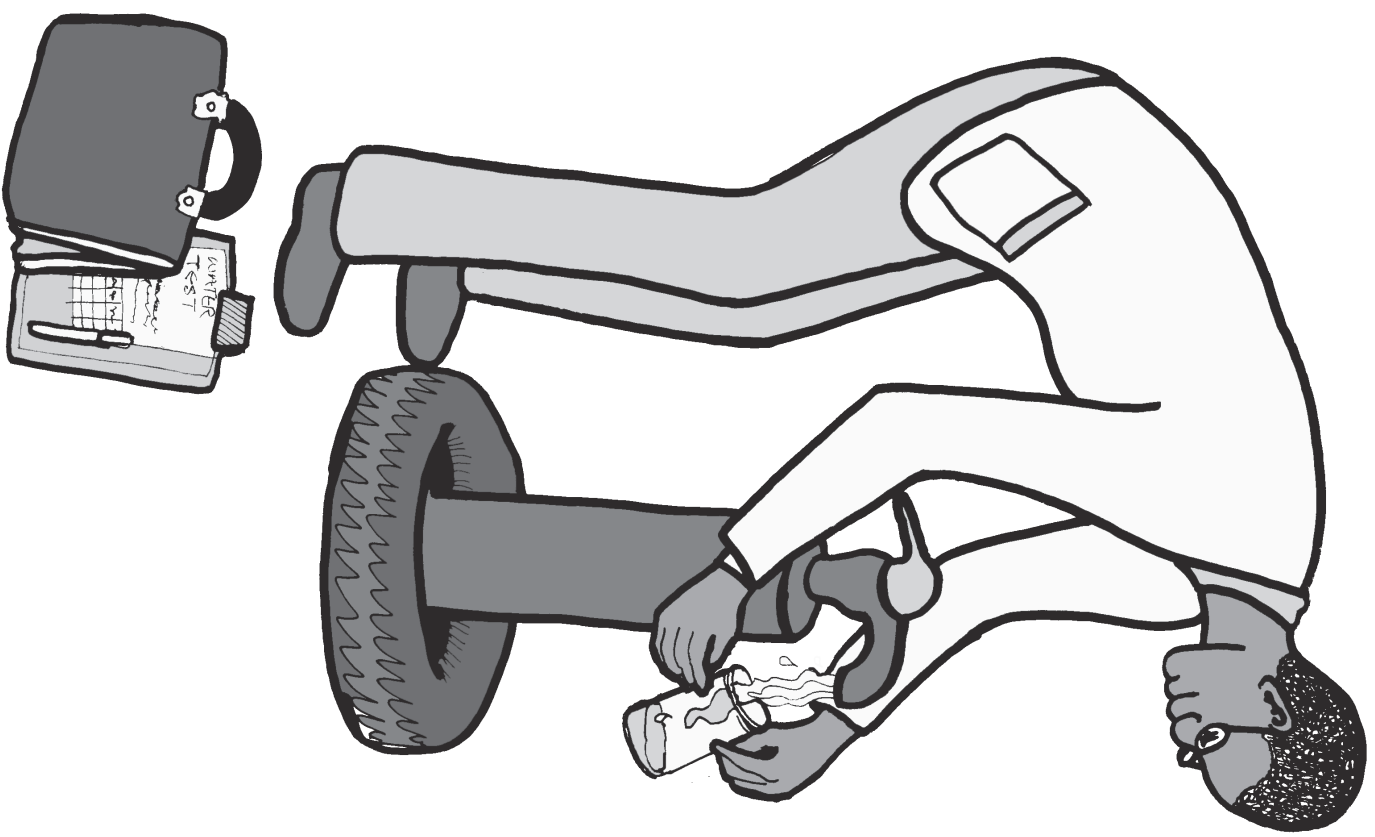
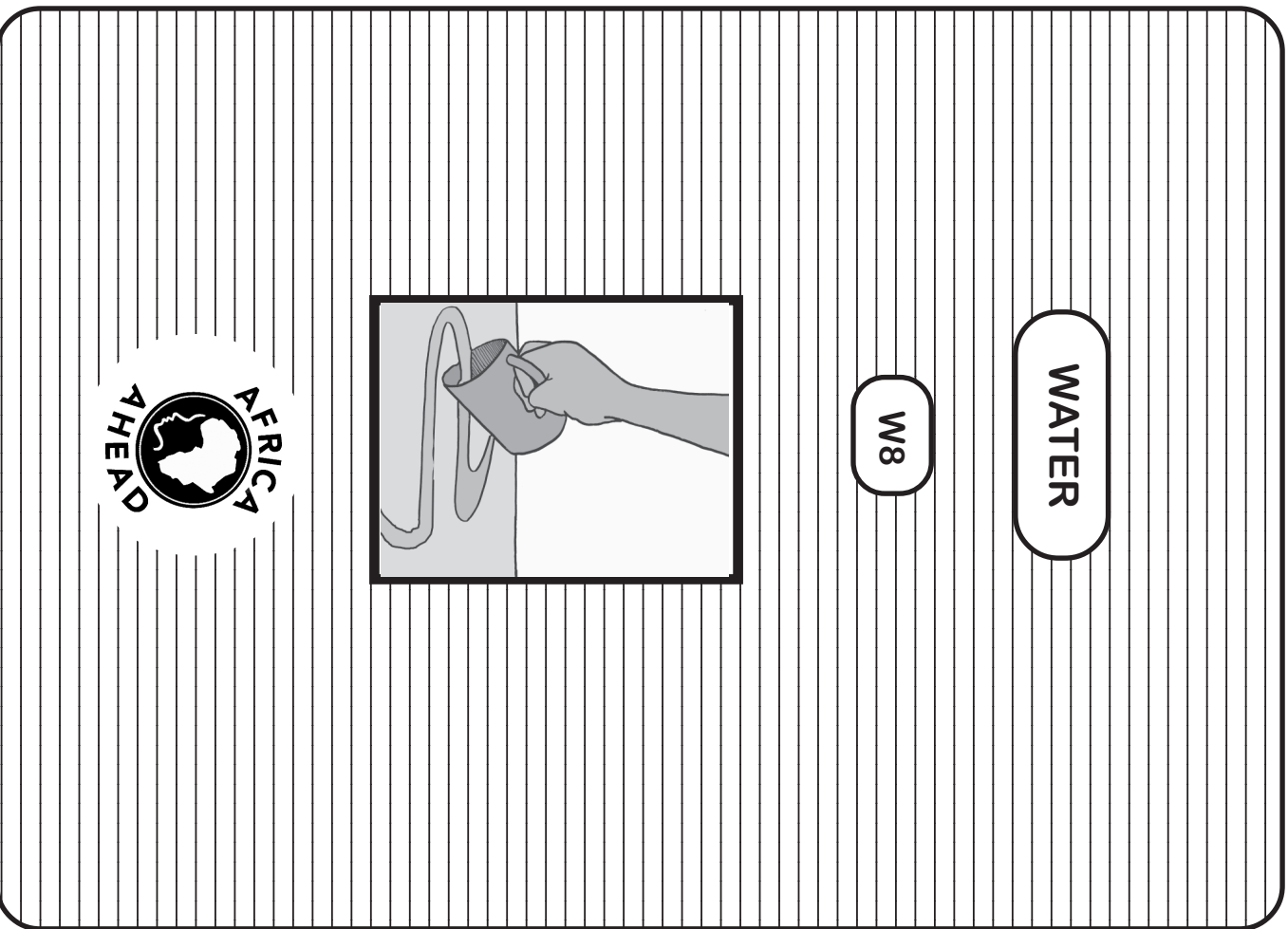

Visual Aids developed by J.Waterkeyn, (Africa AHEAD) for City Health Department Cape Town, 2007.  
Funded by Danida / Hygiene Promotion Partnership.  
Illustrator: T Waterkeyn

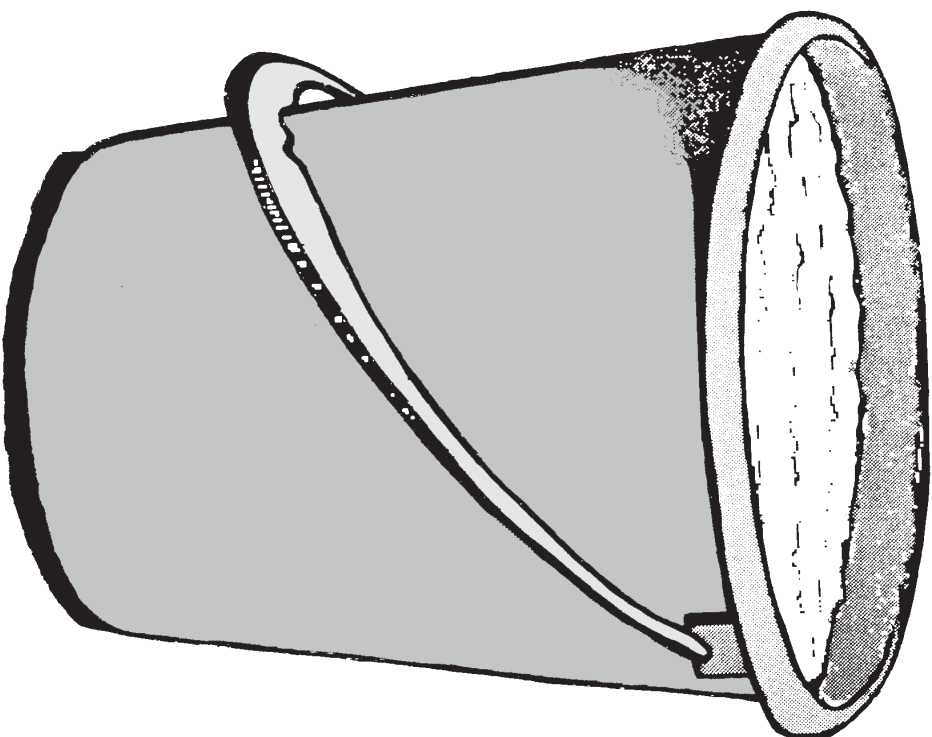
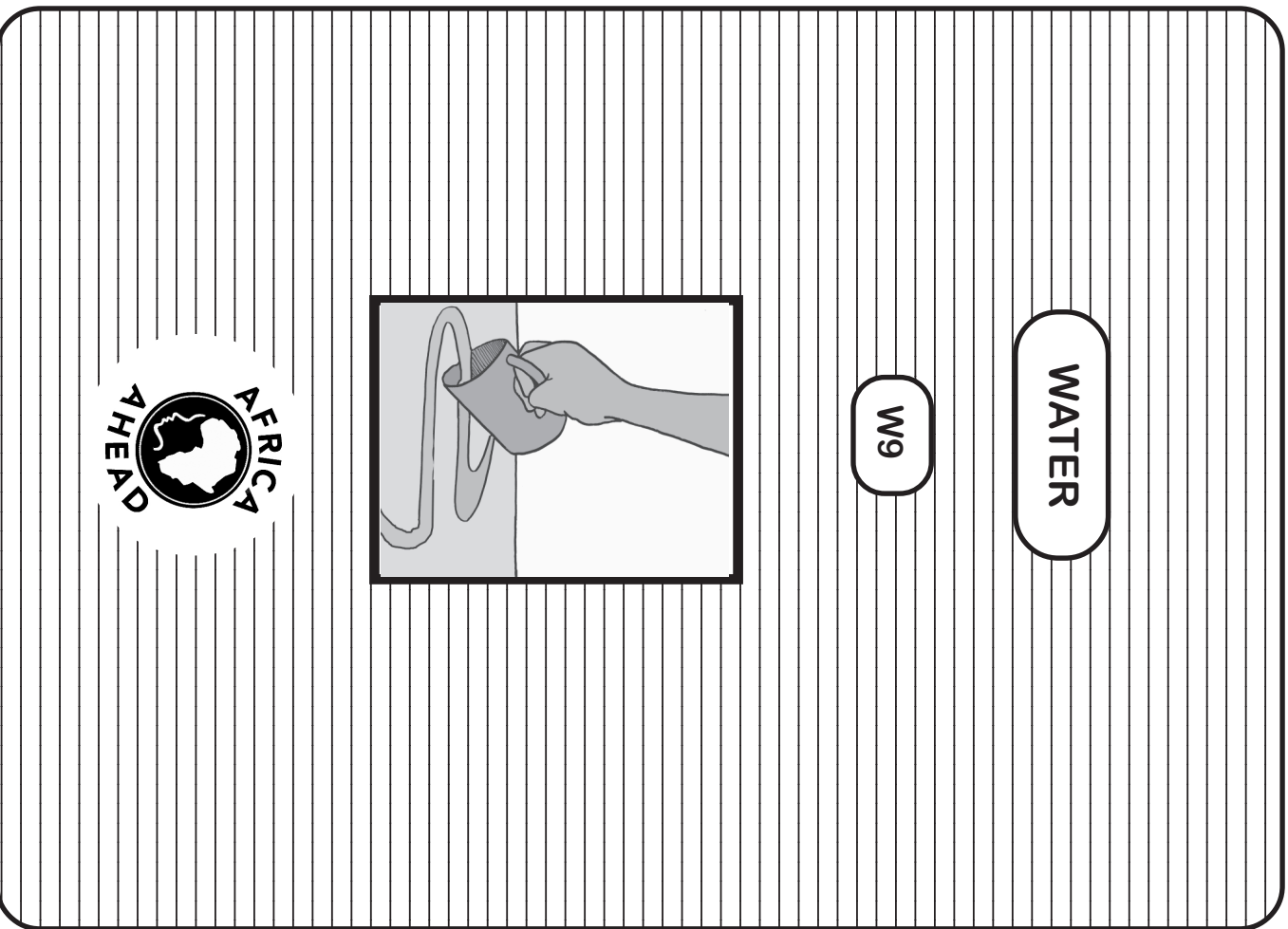

Visual Aids developed by J.Waterkeyn, (Africa AHEAD) for City Health Department Cape Town, 2007.  
Funded by Danida / Hygiene Promotion Partnership.  
Illustrator: B. Madekurozwa (Zim AHEAD)

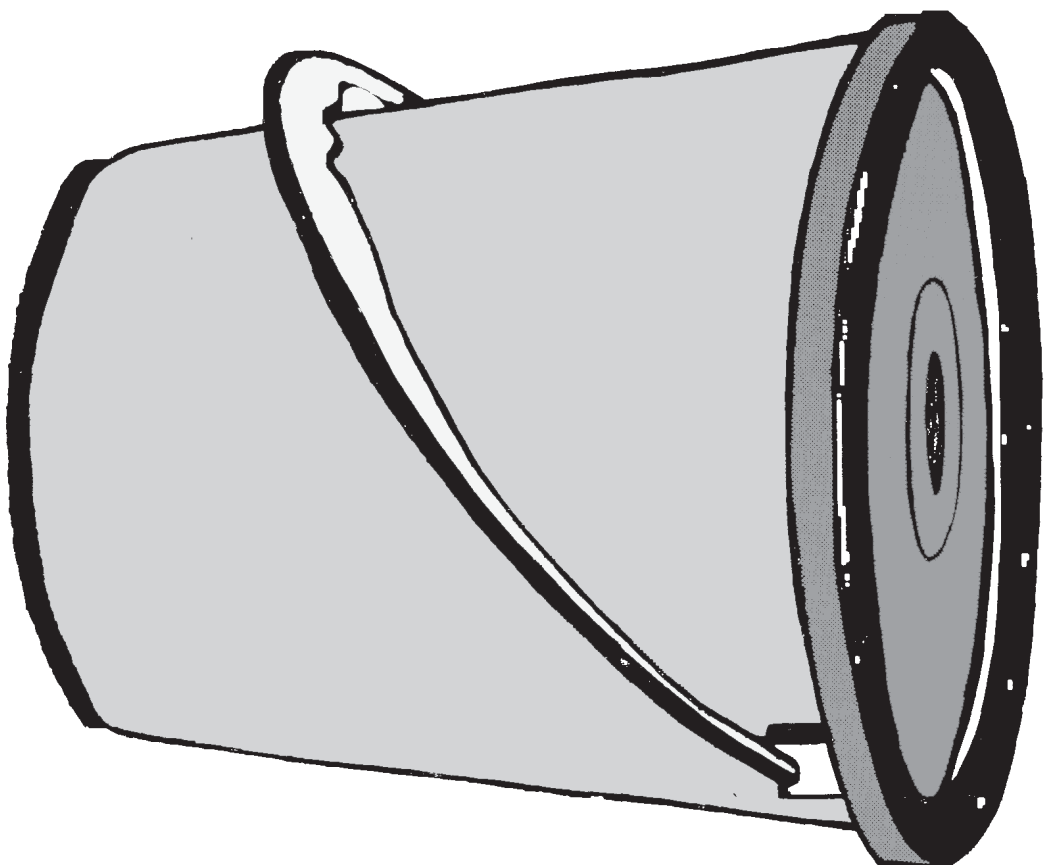
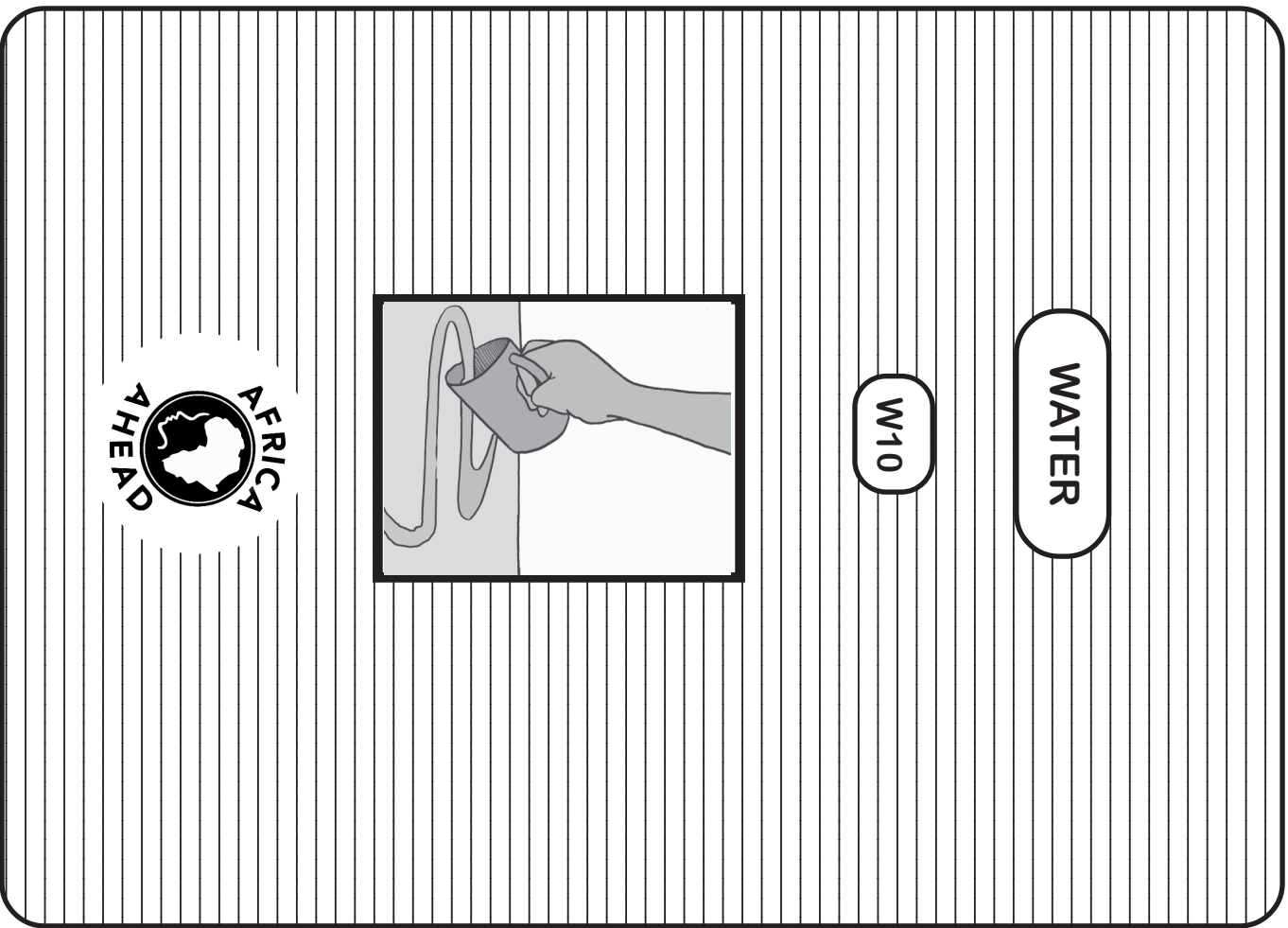

Visual Aids developed by J.Waterkeyn, (Africa AHEAD) for City Health Department Cape Town. 2007.  
Funded by Danida / Hygiene Promotion Partnership.  
Illustrator: B. Madekurozwa (Zim AHEAD)

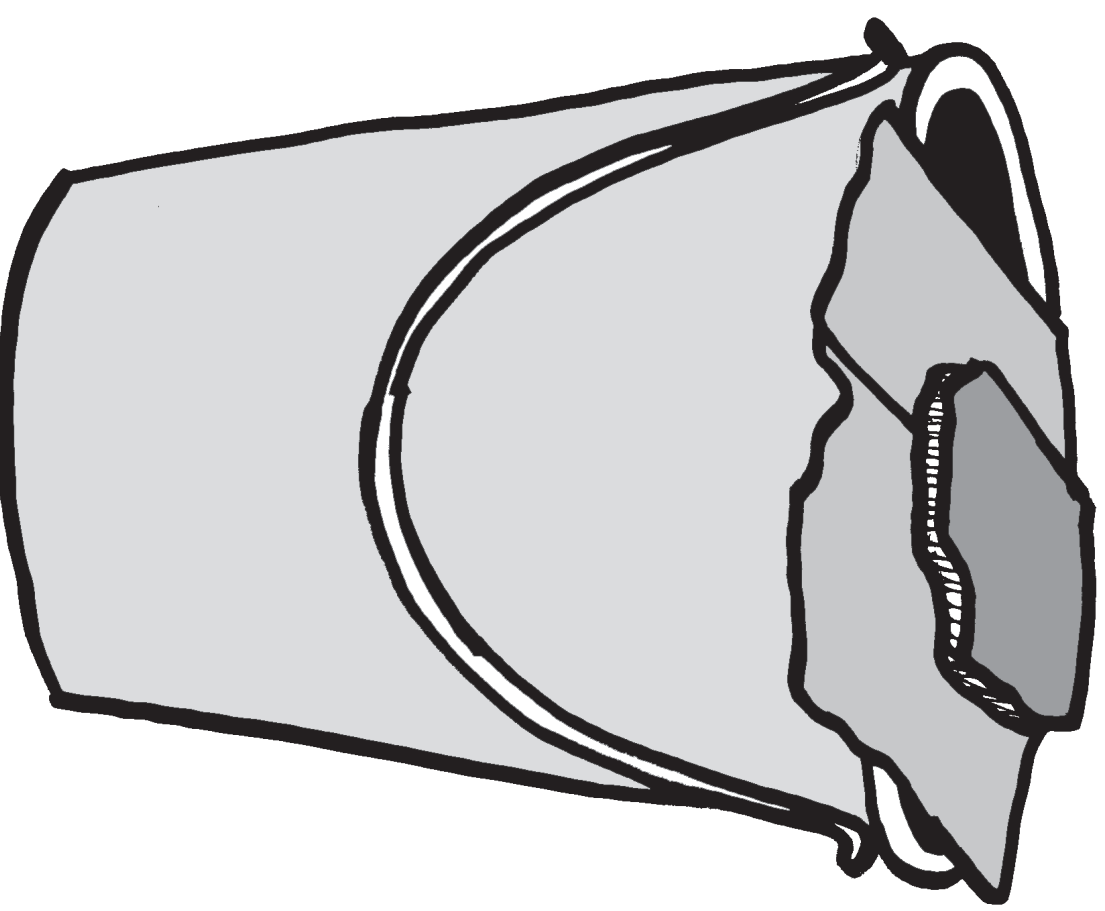
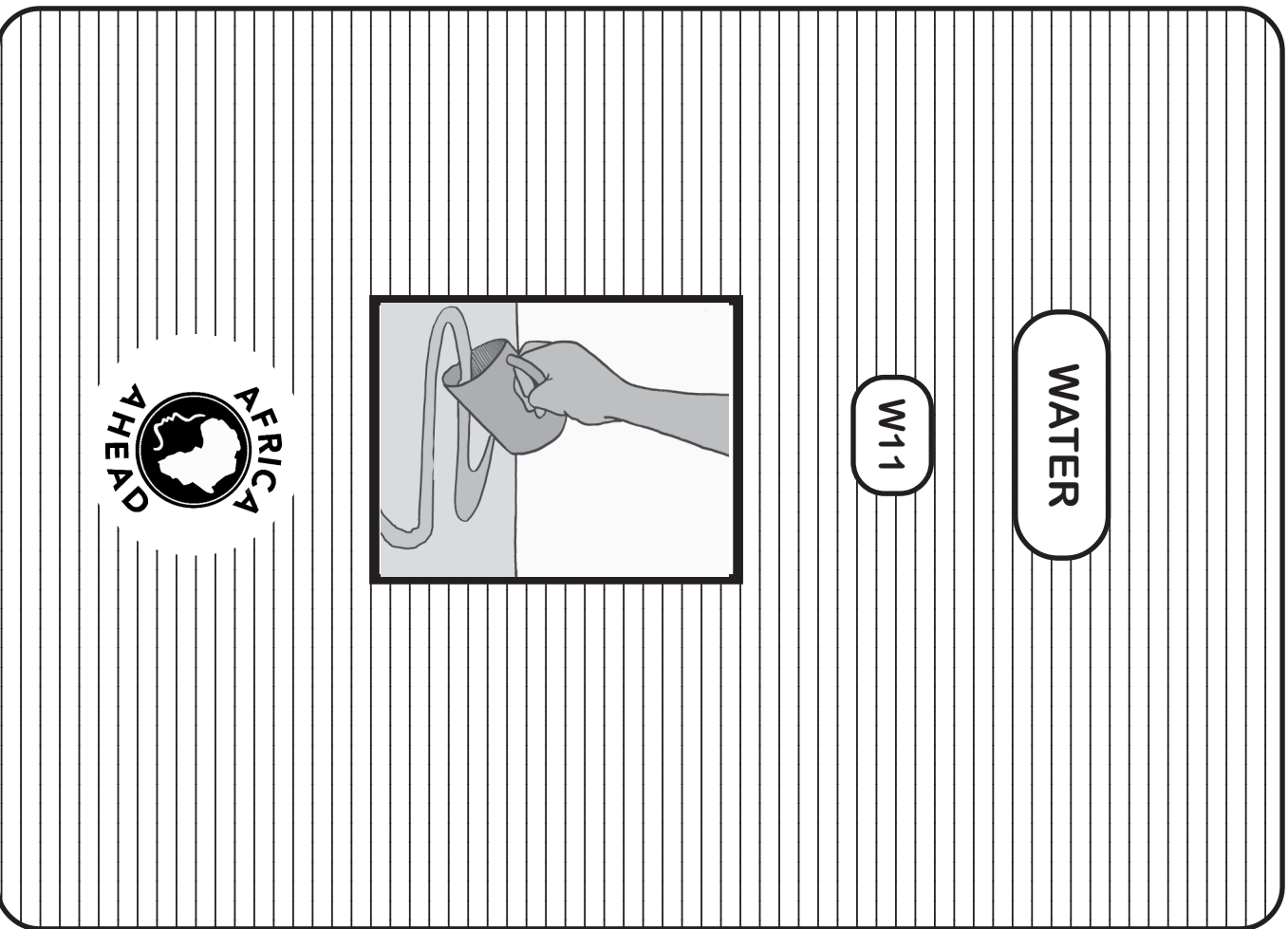

Visual Aids developed by J.Waterkeyn, (Africa AHEAD) for City Health Department Cape Town. 2007.  
Funded by Danida / Hygiene Promotion Partnership.  
Illustrator: B. Madekurozwa (Zim AHEAD)

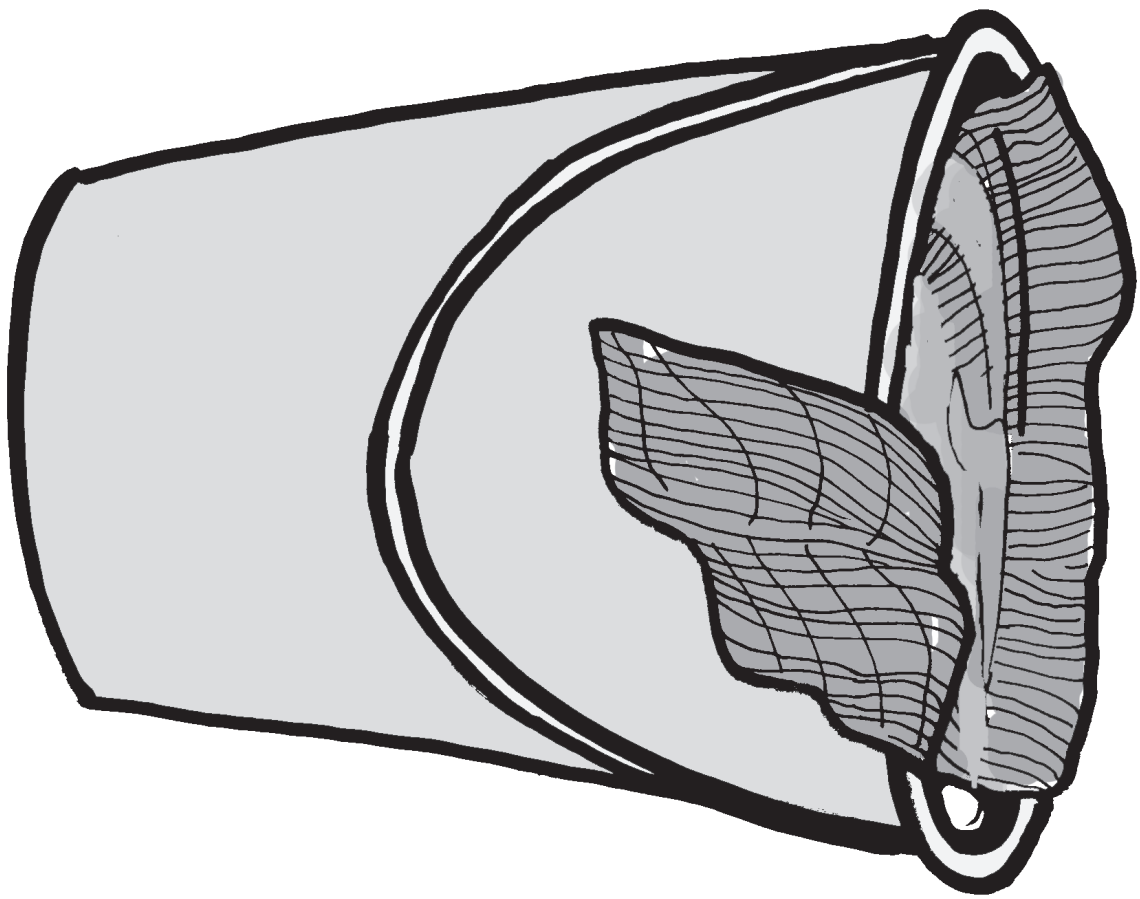
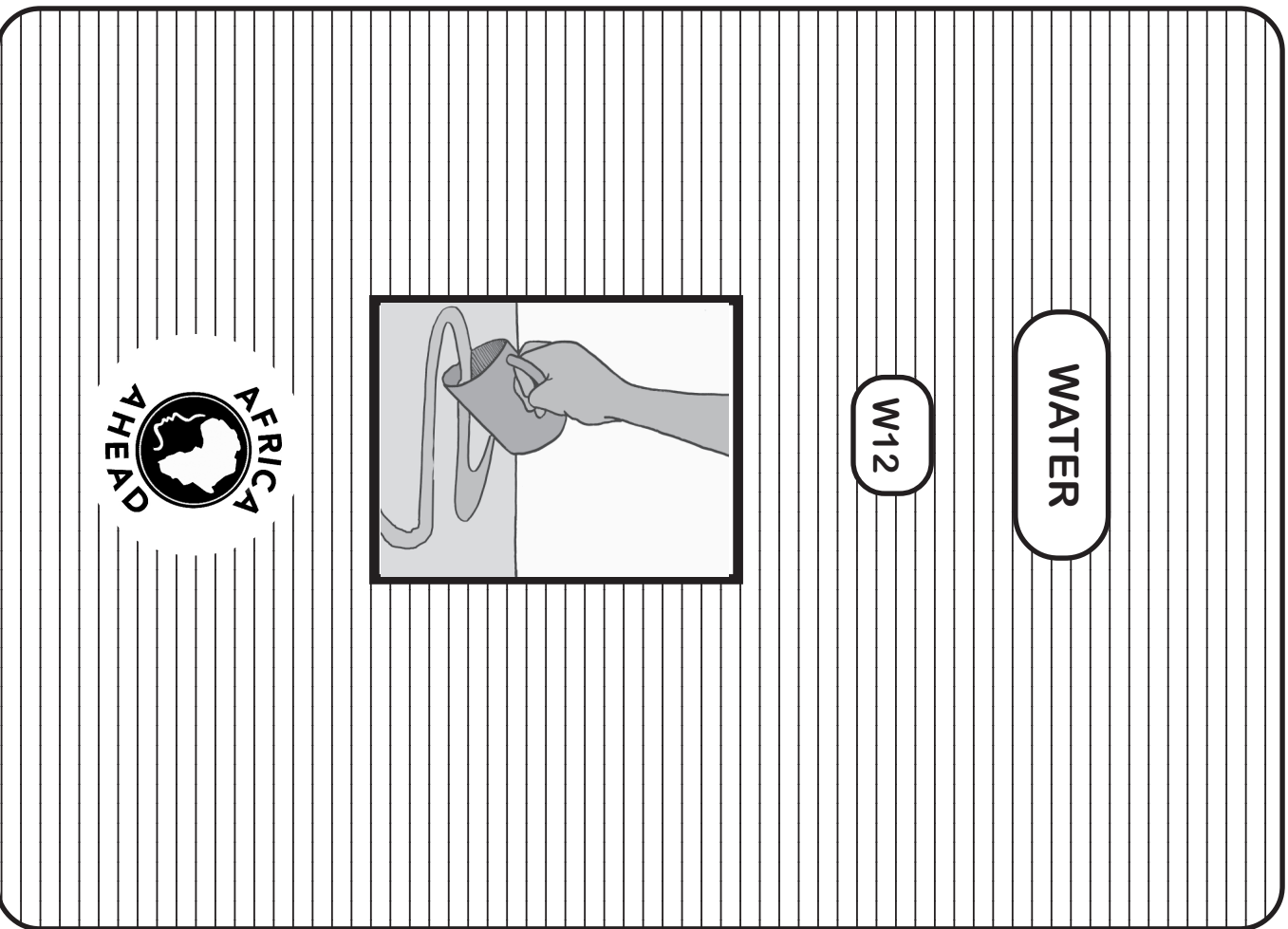

Visual Aids developed by J.Waterkeyn, (Africa AHEAD) for City Health Department Cape Town. 2007.  
Funded by Danida / Hygiene Promotion Partnership.  
Illustrator: B. Madekurozwa (Zim AHEAD)



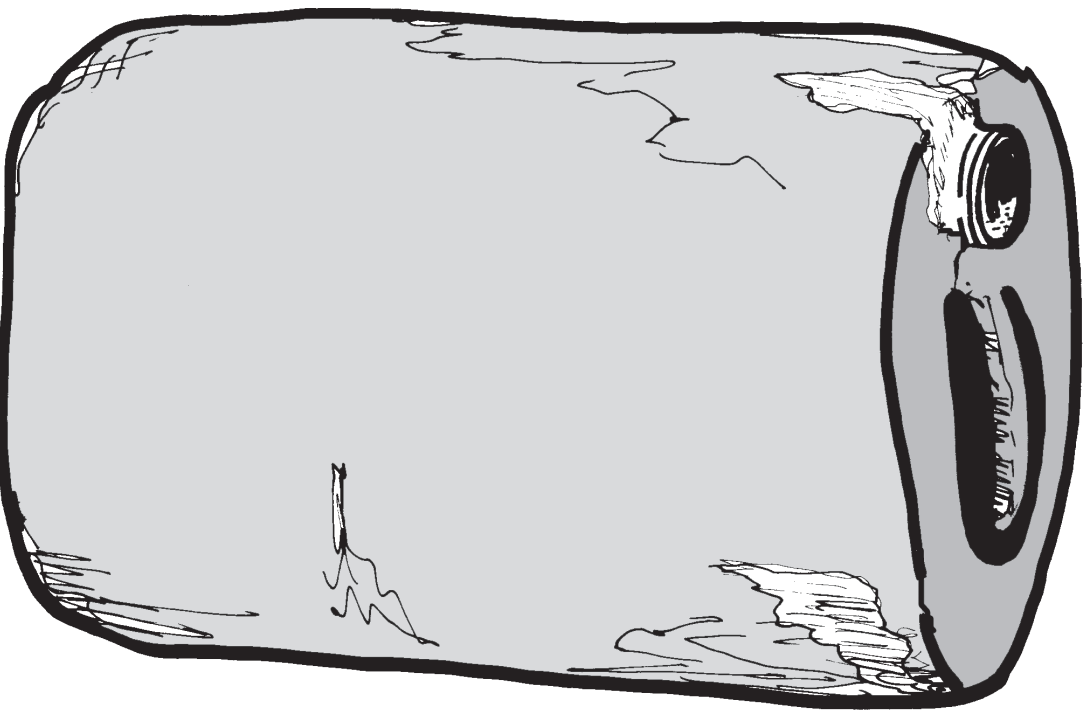
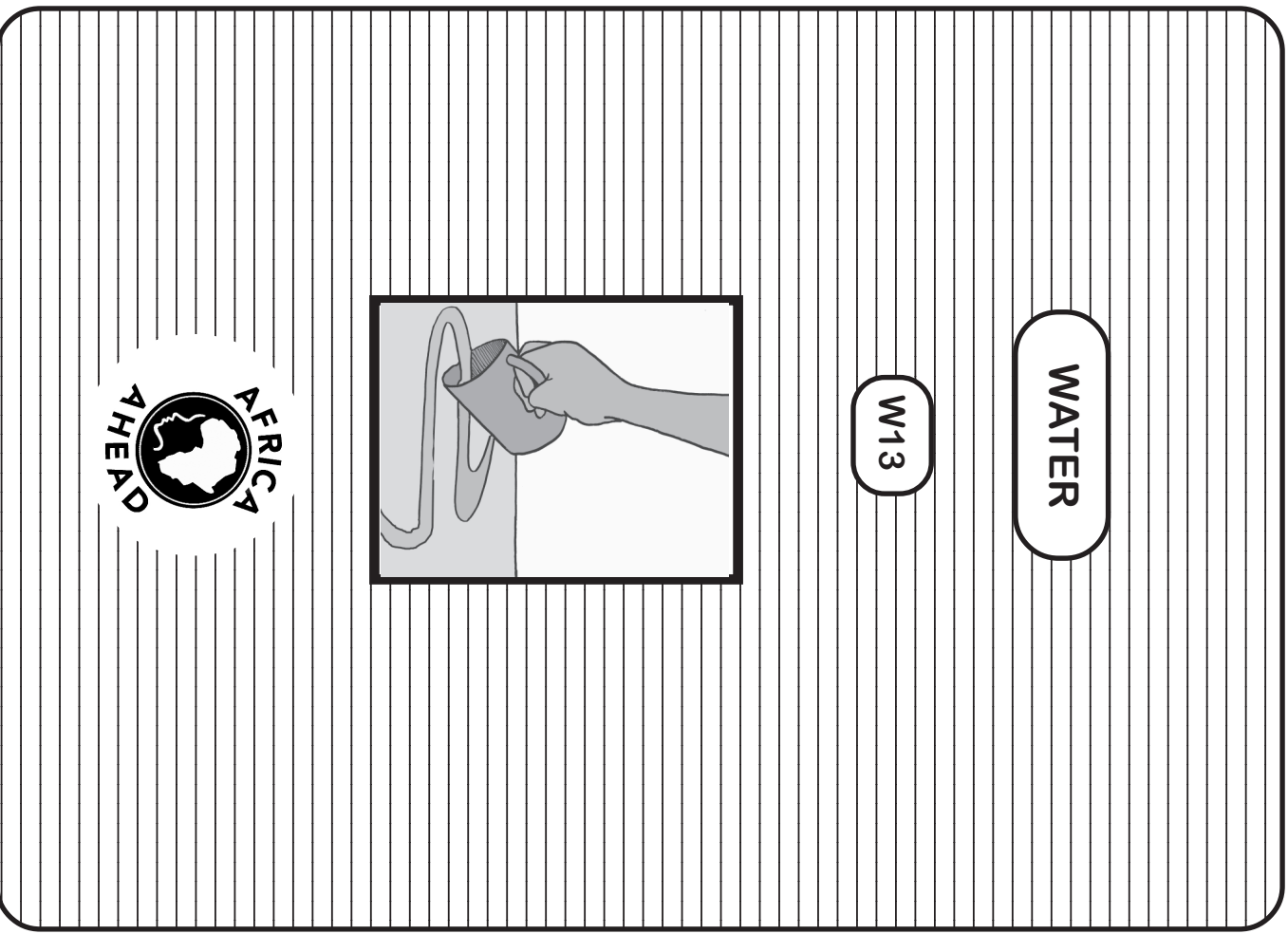

Visual Aids developed by J.Waterkeyn, (Africa AHEAD) for City Health Department Cape Town, 2007.  
 Funded by Danida / Hygiene Promotion Partnership.  
 Illustrator: B. Madekurozwa (Zim AHEAD)

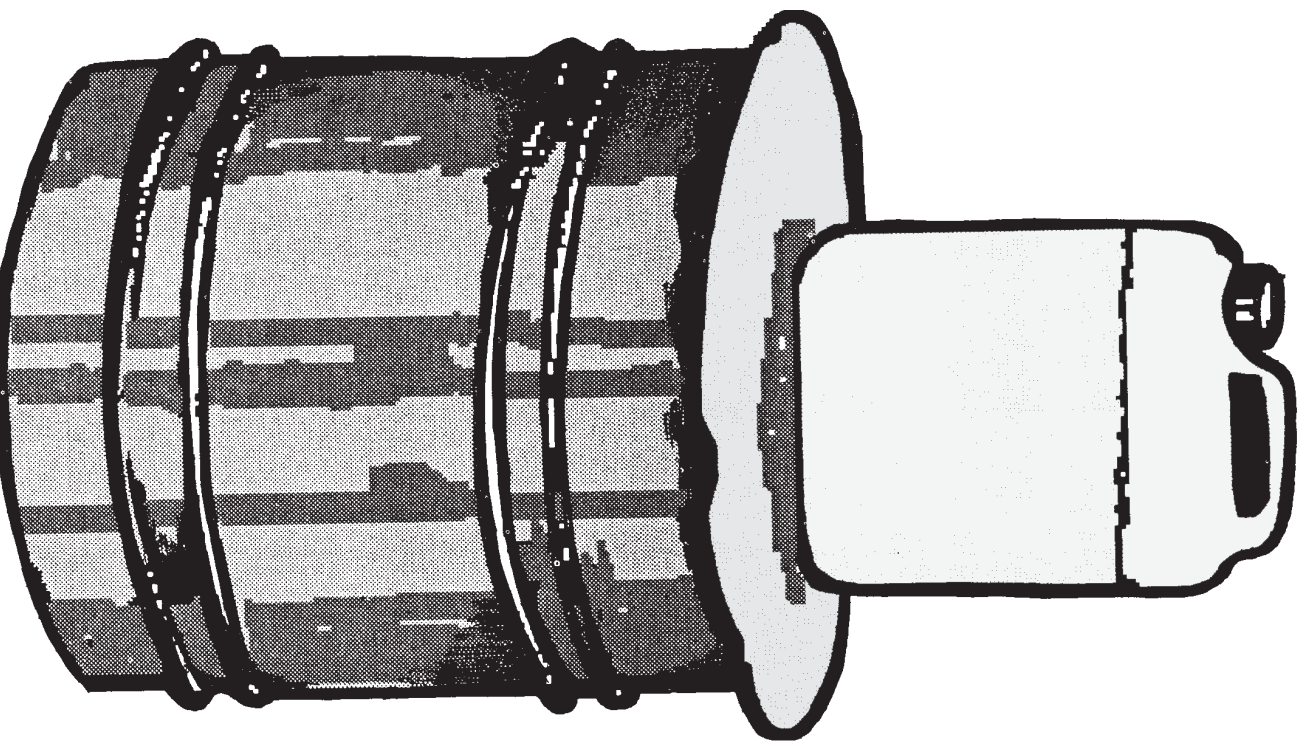
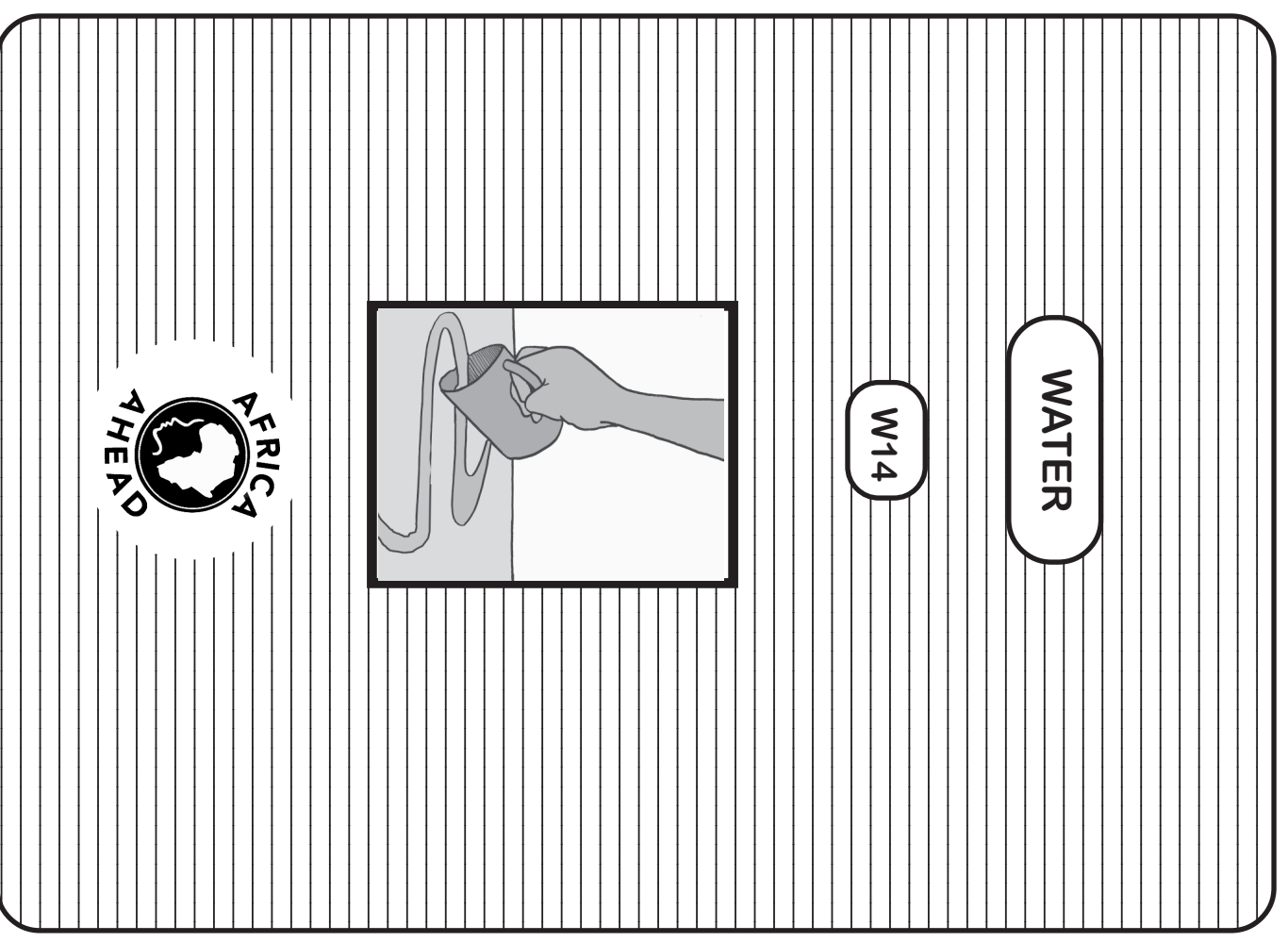

Visual Aids developed by J.Waterkeyn, (Africa AHEAD) for City Health Department Cape Town, 2007.  
Funded by Danida / Hygiene Promotion Partnership.  
Illustrator: B. Madekurozwa (Zim AHEAD)



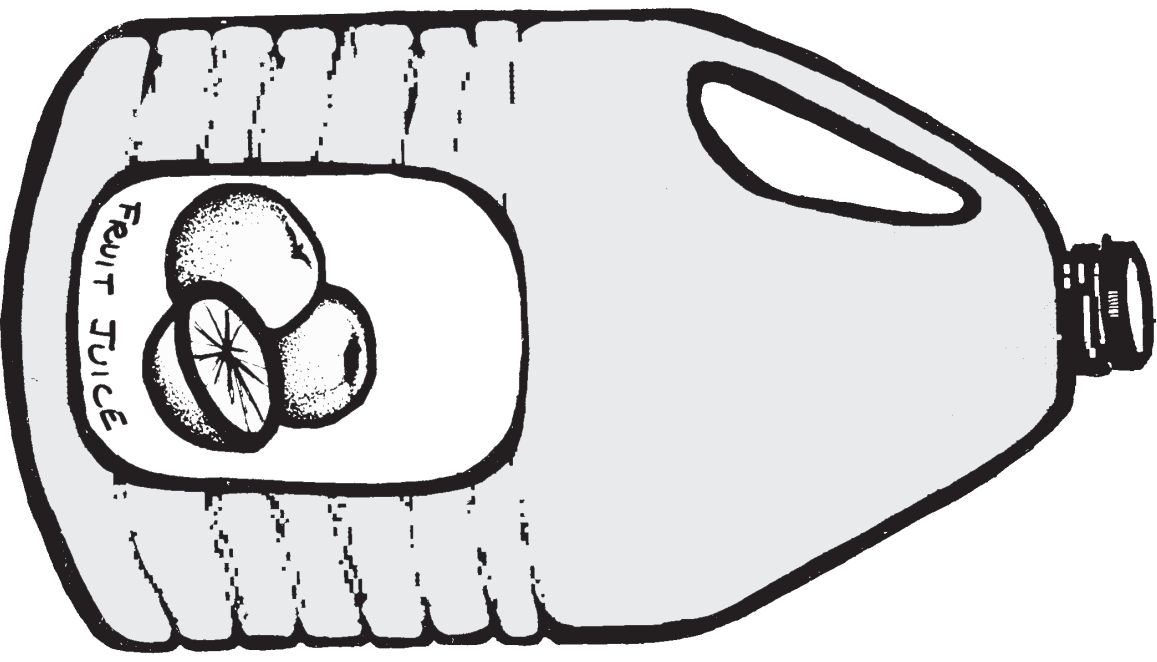
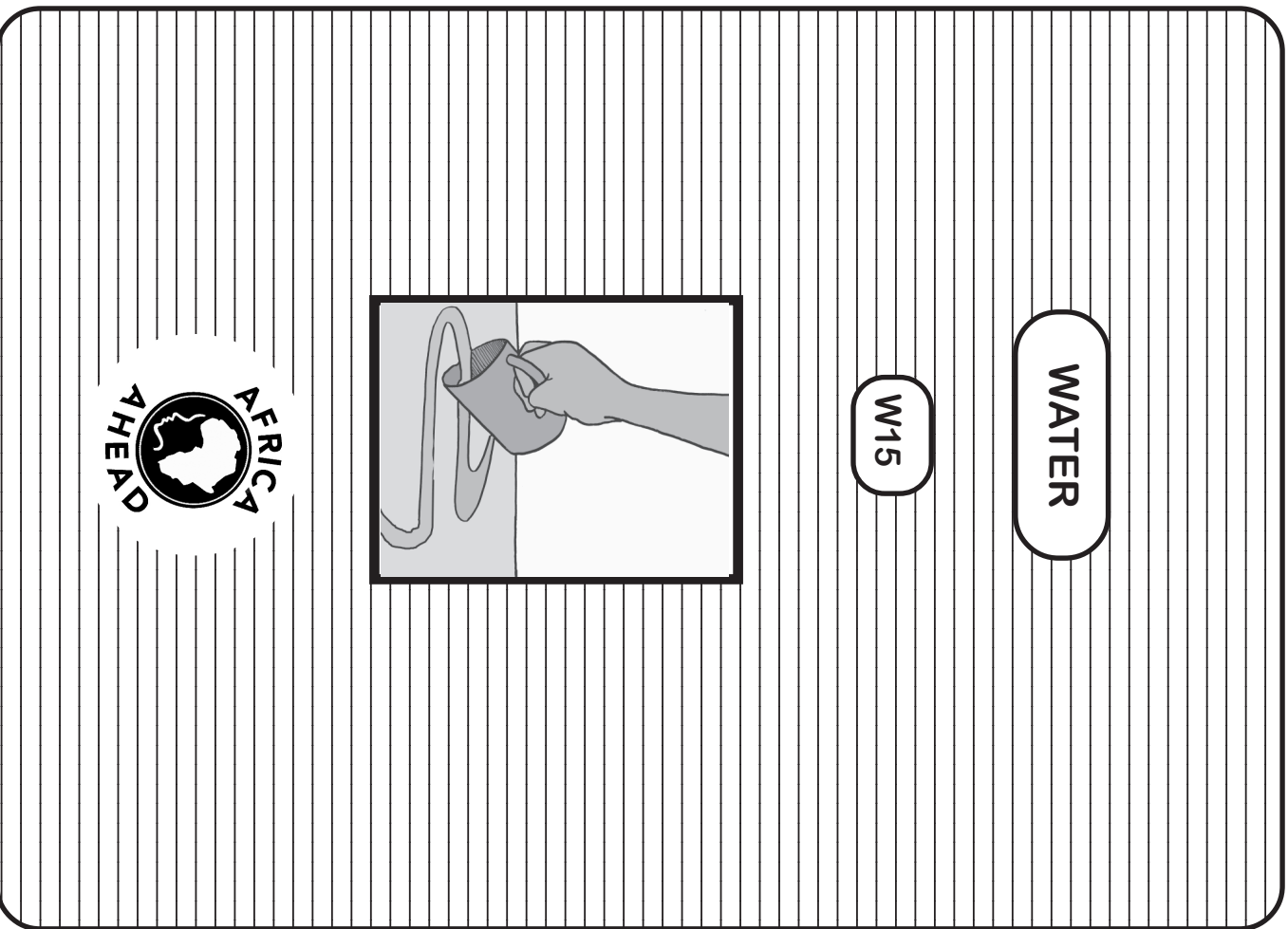

Visual Aids developed by J.Waterkeyn, (Africa AHEAD) for City Health Department Cape Town. 2007.  
Funded by Danida / Hygiene Promotion Partnership.  
Illustrator: B. Madekurozwa (Zim AHEAD)

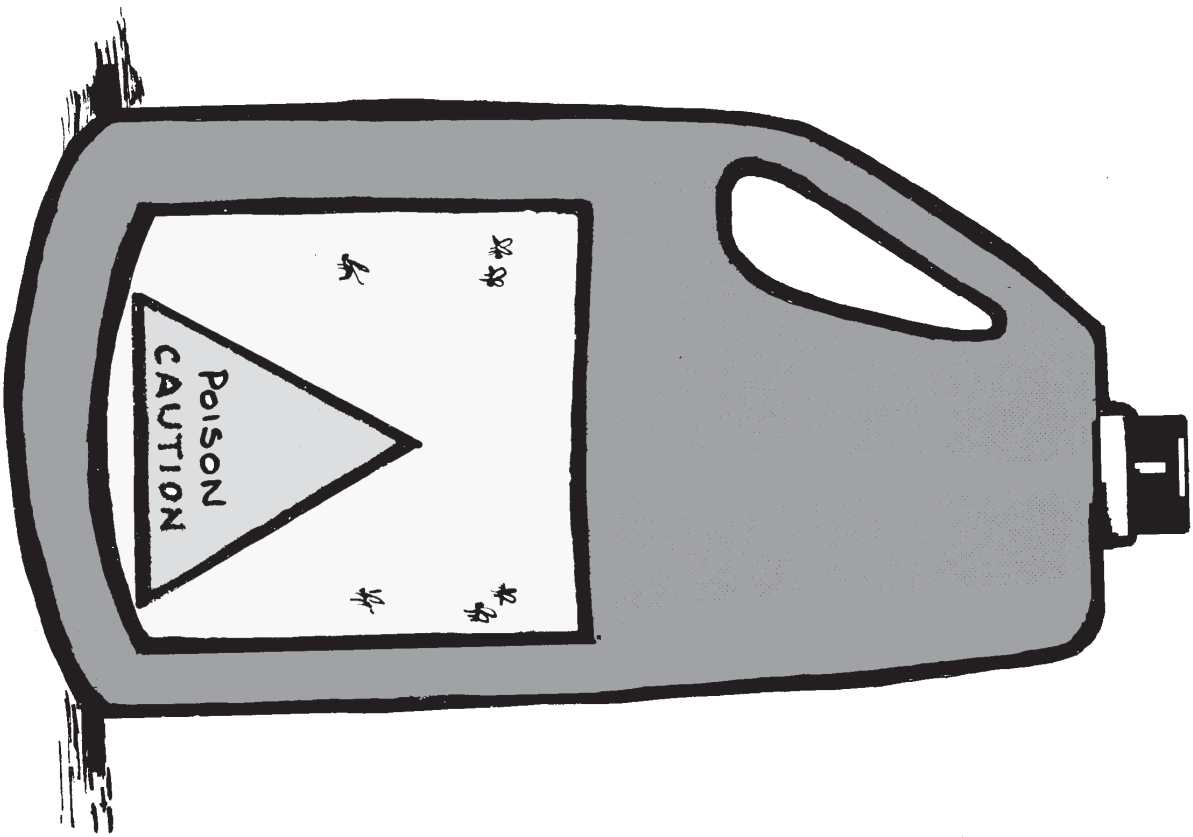
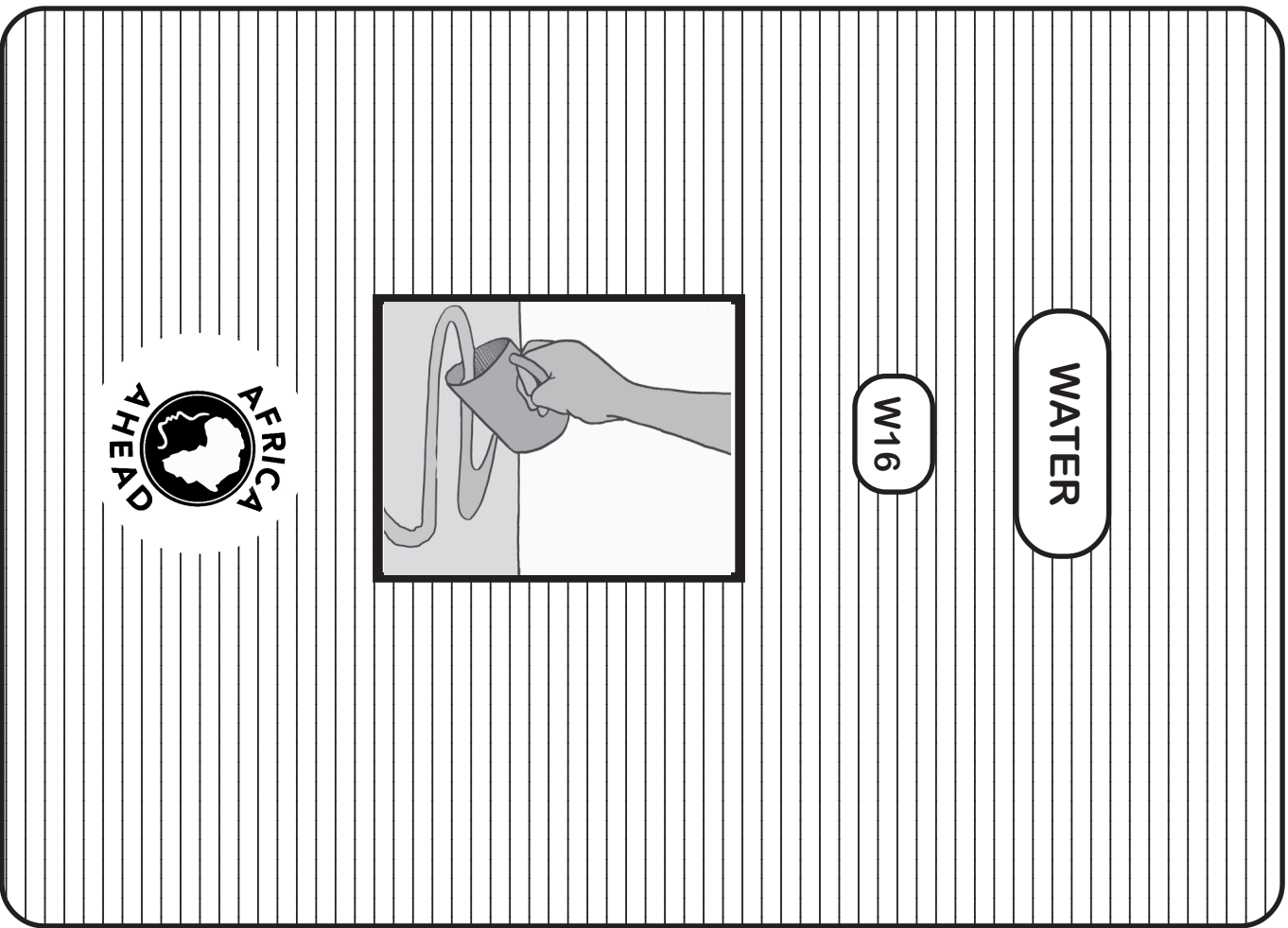

Visual Aids developed by J.Waterkeyn, (Africa AHEAD) for City Health Department Cape Town. 2007.  
 Funded by Danida / Hygiene Promotion Partnership.  
 Illustrator: B. Madekurozwa (Zim AHEAD)